



Mini-Mc RATCHET FACER ASSEMBLY

NOTE: THIS DRAWING AND THE INFORMATION CONTAINED THEREIN IS THE CONFIDENTIAL AND PROPRIETARY PROPERTY OF McElroy Manufacturing, Inc. THE DRAWING IS NOT TO BE REPRODUCED IN ANY MANNER, SUBMITTED OUTSIDE PARTIES FOR EXAMINATION, OR USED DIRECTLY OR INDIRECTLY FOR THE PURPOSES OTHER THAN THOSE FOR WHICH IT WAS FURNISHED WITHOUT WRITTEN PERMISSION OF McElroy Manufacturing, Inc.

NOTES:

1. INSTALL SHARP EDGE OF CUTTER HOLE NEXT TO HUB AS SHOWN.
2. INSERT SET NUMBERS:
 CTS15017 INCLUDES (2) CTS15007 1" IPS RATCHET FACER INSERT.
 CTS15018 INCLUDES (2) CTS15008 1/2" CTS RATCHET FACER INSERT.
 CTS15019 INCLUDES (2) CTS15009 1" CTS RATCHET FACER INSERT.
 CTS15020 INCLUDES (2) CTS15010 3/4" IPS RATCHET FACER INSERT.
 CTS15021 INCLUDES (2) CTS15011 3/4" CTS RATCHET FACER INSERT.
 CTS15022 INCLUDES (2) CTS15012 1/2" IPS RATCHET FACER INSERT.

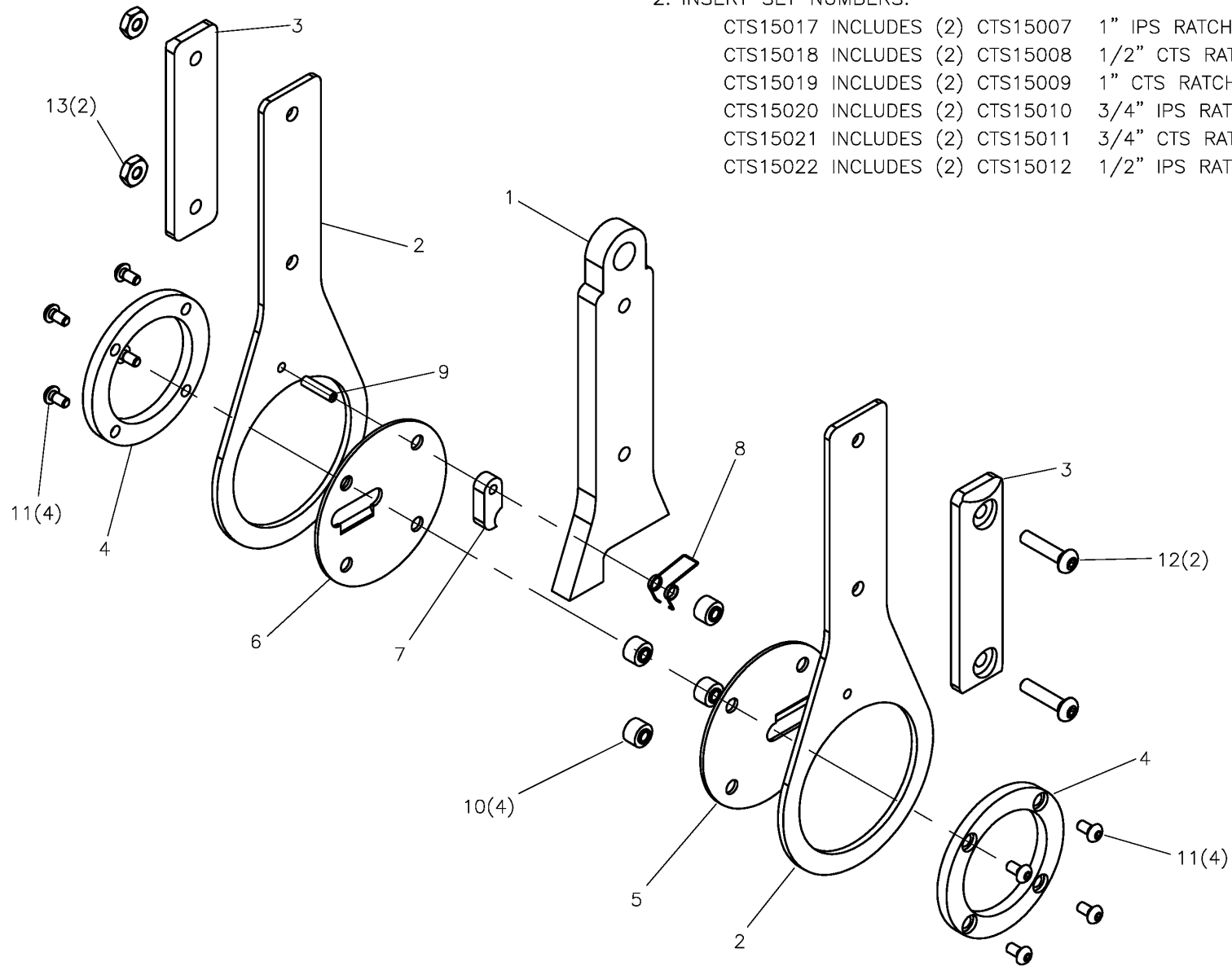

McElroy Manufacturing Parts List

Part Number: CTS15014 MiniMc Ratchet Facer Assembly



Mnmc ratchet for assy

Part Number CTS15014 Component List

Item	Component	Description	Quantity	Unit	Price
1	CTS15002	Ratchet Fcr Handle Spacer	1.0	EA	92.00
2	CTS15006	Ratchet Fcr Facing Block Hldr	2.0	EA	88.34
3	CTS15003	Ratchet Fcr Handle	2.0	EA	41.50
4	CTS15001	Ratchet Fcr Hub	2.0	EA	84.30
5	CTS06801	Facer Cutter Disc	1.0	EA	70.28
6	CTS06802	Facer Cutter Disc	1.0	EA	78.51
7	CTS15005	Ratchet Fcr Pawl	1.0	EA	54.22
8	CTS15013	Ratchet Fcr Torsion Spring	1.0	EA	19.16
9	MCG00003	1/8DIAX1/2LG Roll Pin	1.0	EA	0.11
10	CTS15004	Ratchet Fcr Spacer	4.0	EA	18.45
11	MAN00034	#5-40NCX1/4LG Bhscs SS	8.0	EA	0.77
12	MAN00035	#8-32NCX3/4LG Bhscs SS	2.0	EA	0.22
13	MBA00003	#8-32NC Hex Nut Stil PL	2.0	EA	0.31

Please visit <https://fusion.mcelroy.com/parts> to purchase parts or for more information.